

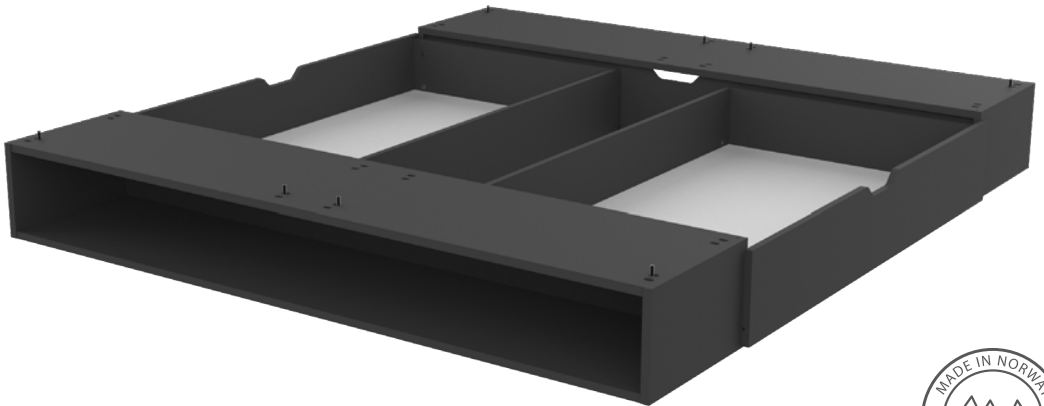

WONDERLAND BASEBOX

MONTERINGSANVISNING





x12



x24



x32



x8

STEP 1

MONTER TREPLUGGER OG EUROBOLTER

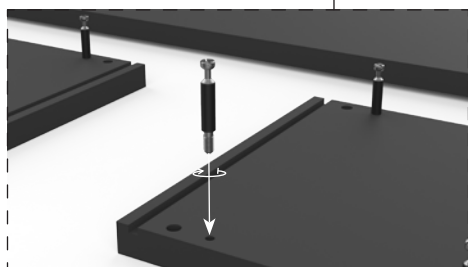
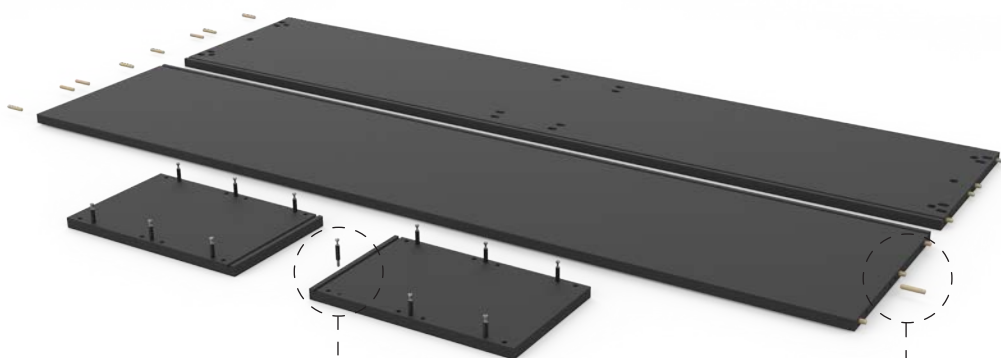

EUROBOLTER

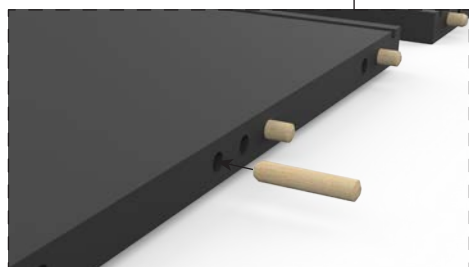

TREPLUGGER

STEP 2

MONTER TOPPLATEN, BUNNPLATEN, OG DEN ENE ENDEPLATEN



BAKPLATEN SKYVES INN I SPORET

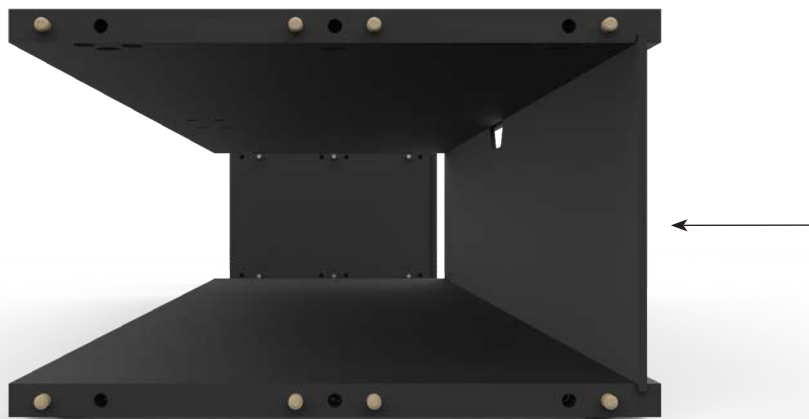

STEP 3

MONTER DEN SISTE SIDEPLATEN



STEP 4

SNU UNDERSTELLET OPP NED OG STRAM EUROBOLTENE MED EXCENTERSNEKKENE
MONTER MØBELKNOTTENE

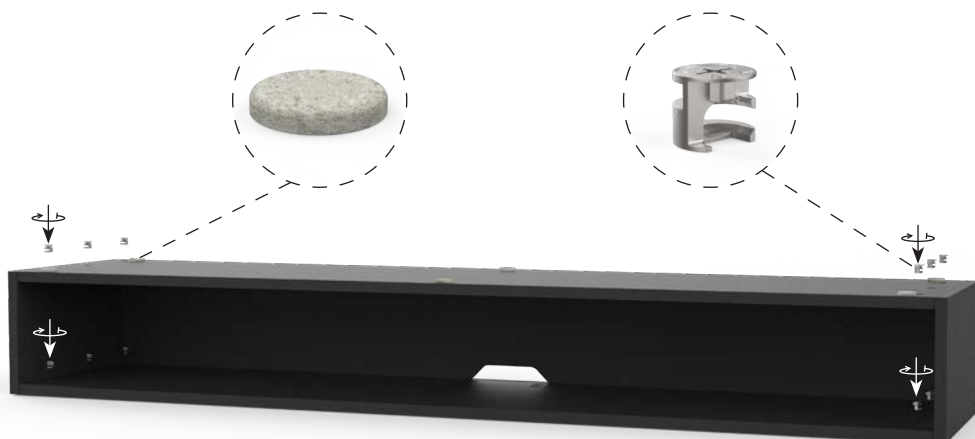



x8



x24



x32

STEP 1

MONTER TREPLUGGER, EUROBOLTER OG HJUL

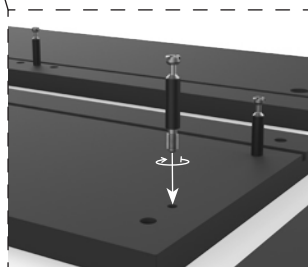
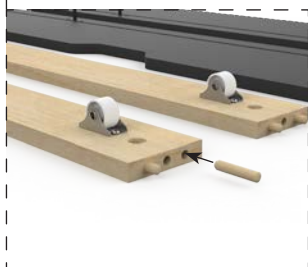
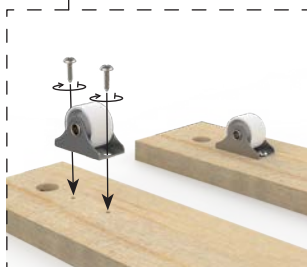
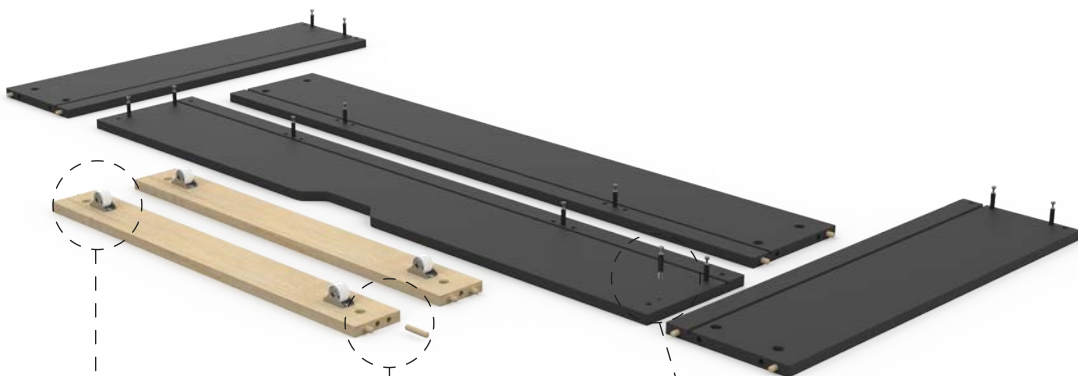

STEP 2

MONTER BAKPLATEN, SIDEPLATENE OG DE TO SARGENE MED HJUL

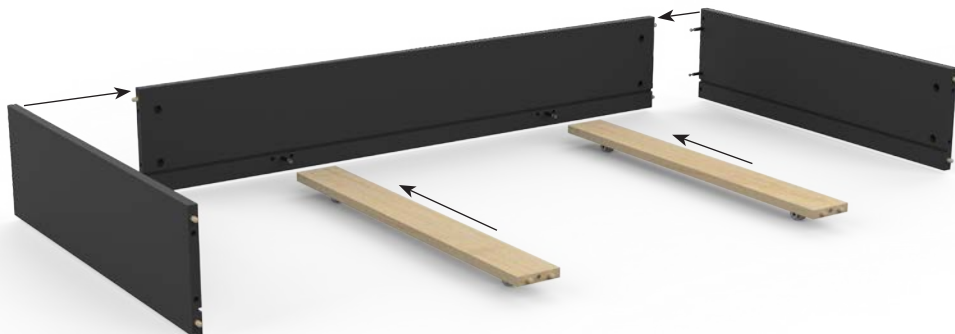

STEP 3

SYV BUNNPLATEN INN I SPORET

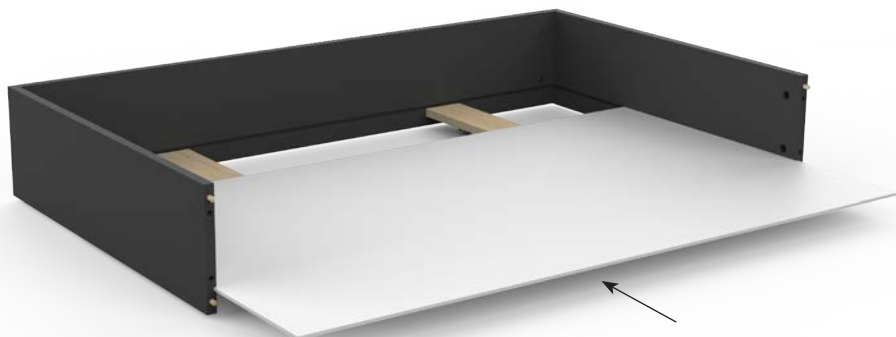

STEP 4 MONTER FRONTEN



STEP 5 STRAM ALLE EUROBOLTENE MED EXCENTERSNEKKENE



FOR RAMMESENG MONTERING AV UNDERSTELLET PÅ SENGEN

BRUK DE NNERSTE HULLENE TIL MONTERING I SENGERRAMMEN

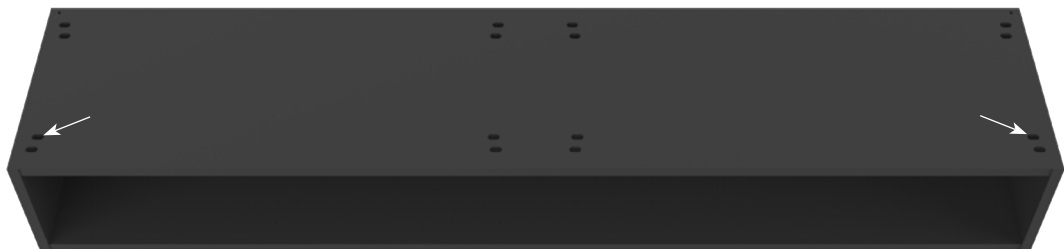

MONTER UNDERSTILLENE TIL SENGENS RAMME

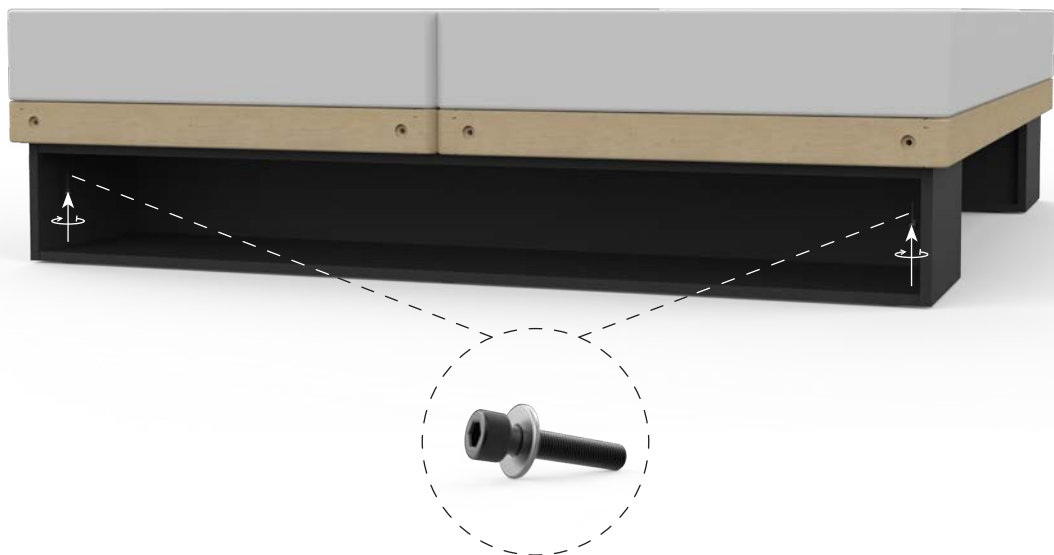

FOR RAMMESENG MONTERING AV UNDERSTELLET PÅ SENGEN

KONTROLLER AT SKUFFENE BEVEGER SEG FRITT MELLOM UNDERSTELLENE FØR SKRUENE STRAMMES

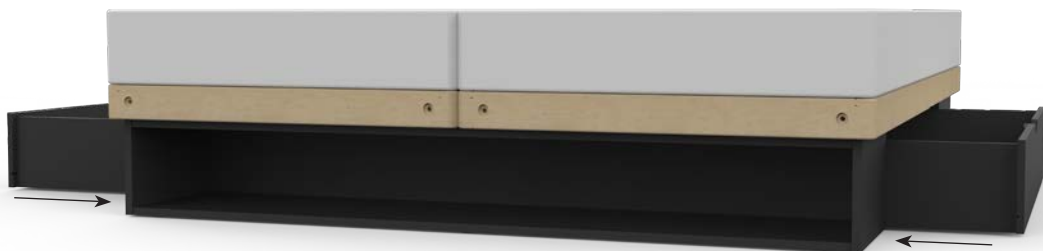

TA PÅ TREKKET, SOV GODT



FOR REGULERBAR SENG MONTERING AV UNDERSTELLET PÅ SENGEN

BRUK DE YTTERSTE HULLENE TIL MONTERING I SENGERAMMEN

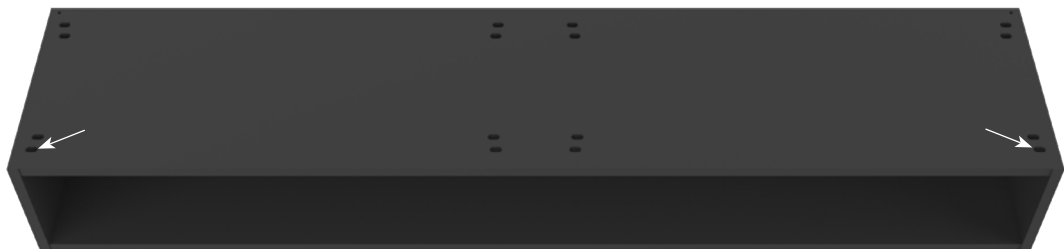

MONTER UNDERSTILLENE TIL SENGENS RAMME

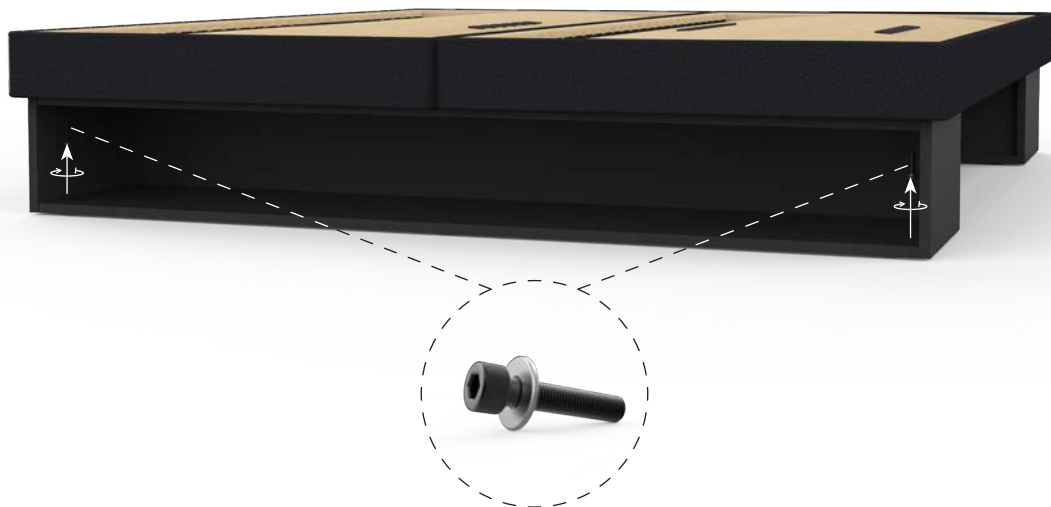

FØR REGULERBAR SENG MONTERING AV UNDERSTELLET PÅ SENGEN

KONTROLLER AT SKUFFENE BEVEGER SEG FRITT MELLOM UNDERSTELLENE FØR SKRUENE STRAMMES



TA PÅ TREKKET, SOV GODT



